

They are designed to replace the lead-acid battery, which are available for drop-in replacement in the Club Car and EZ-GO etc. vehicles nicely.

- MODEL** B-LFP36-100GC
- VOLTAGE** 38.4V (Display voltage: 39.6V)
- NOMINAL CAPACITY** 104Ah
- CASE** METAL/FR
- BATTERY** Lithium-iron (LFP)
- COLOR** BLACK
- CYCLE LIFE** 3500 @80%DOD
- INTELLIGENCE** Multiple Microprocessors, State of Charge Gauge with Aging Compensation, Current Sensor, Fuse, CAN Bus



**ELECTRICAL SPECIFICATIONS**

Battery Types	Lithium-iron (LFP)
Rated Capacity	104Ah
Nominal Voltage	38.4V Display voltage: 39.6V
Operating Voltage Range	30V~43.2V Battery cell: 2.5V~3.65V
System Capacity	3.994 KWh
Battery Group Solution	2P12S A boxful
IP Protection Level	Battery system IP54
Cycle Life	> 3500 times 25°C, 05C charge, 1C discharge, DOD 70% ( soc 0~100% )
Battery System Weight	40KG
Calendar Life	12 years 25°C, SOC 100%, EOL 80%

**TEMPERATURE SPECIFICATIONS**

Operating Temperature Range A Column Temperature	Charge	0°C~55°C
	Discharge	-20°C +55°C

**PHYSICAL SPECIFICATIONS**

Battery Pack Factory SOC	50%
Battery SOC Operating Range	0~100%
Insulation Requirements	≥20MΩ/1000VDC 25°C ± 5°C, RH50%
The Power Consumption Of The BMS	≤3W
SOC Theory Estimation Accuracy	±5%
Unit Voltage Acquisition Accuracy	±5mV Capture every single monomer
Temperature Acquisition Accuracy	±2°C 4 road
Current Acquisition Accuracy	≤ ± 0.5% FSR
Equalizing Current	≤ 100mA Passive equalization
Protect Function	Over-current protection, over-discharge protection, high and low temperature protection, abnormal alarm function.



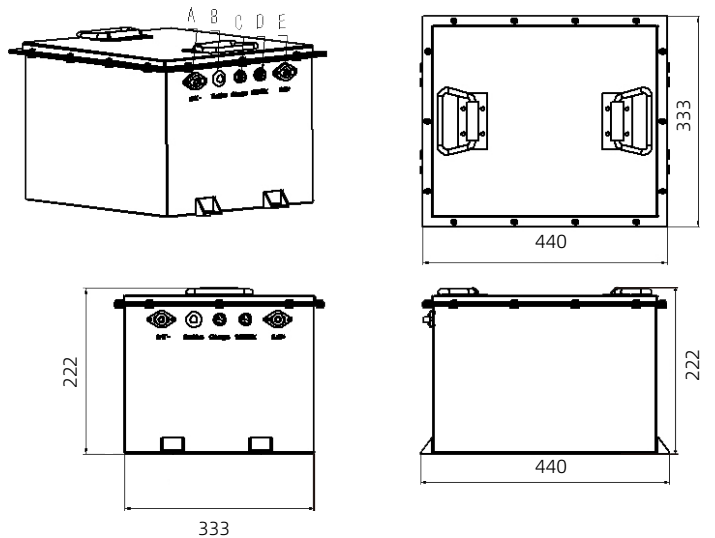



**DIMENSIONAL SPECIFICATIONS**



**DISCHARGE SPECIFICATIONS**

Maximum Continuous Charging Current	50A 10°C~45°C, 5% <SOC < 80%
Maximum Continuous Discharging Current	150A 5°C~50°C, SOC > 20%
Maximum Instantaneous Charging Current (10S)	100A 10°C~45°C, 5% <SOC < 80%
Maximum Instantaneous Discharging Current (10S)	250A 5°C~50°C, SOC > 20%
Standard Charging Current Is Recommended	< 30A
Self-discharge Rate/Month (25°C, SOC100 %)	< 3%

**FIVE YEAR COST COMPARISON BETWEEN BSLBATT & LEAD ACID BATTERIES**

	YEAR 1	YEAR 2	YEAR 3	YEAR 4	YEAR 5
 <b>\$ Cost Of Battery</b>	\$\$\$\$				
 <b>Installation</b>	\$				
 <b>Maintenance</b>					
 <b>Maintenance</b>					
 <b>Maintenance</b>					
 <b>Battery Change</b>					
<b>Total</b>					\$\$\$\$\$\$
 <b>\$ Cost Of Battery</b>	\$				
<b>Installation</b>	\$				
<b>Maintenance</b>		\$			
<b>Maintenance</b>			\$		
<b>Maintenance</b>				\$	
<b>Maintenance</b>					\$
<b>Battery Change</b>					\$
<b>Total</b>					\$\$\$\$\$\$\$\$



Do not mix with lead-acid batteries when recycling to 70% initial capacity

# GOLF

LITHIUM-ION  
BATTERY

## B-LFP36-100

**BSLBATT**  
Best Solution Lithium Battery



### STRUCTURAL DIFFERENCES IN THE BSLBATT GOLF CART SERIES

#### Each Cell Is Encased In Aluminum

- ✔ Provides dimensional stability

#### Steel Battery Bracket

- ✔ Provides vibration and shock resistance

#### External Heat Sink Keeps

- ✔ BMS cool by providing heat dissipation to outside

#### BMS Bolted To Heat Sink

- ✔ Reduces vibration and prevents accidental faults due to vibration and it extends battery life

#### Bolted Connections To BMS

- ✔ Provides stable mechanical and electrical connections

#### Positive And Negative BusBar

- ✔ Creates an exceptional current collector

#### IP54 Rated Casing

- ✔ Ensures water, dust and splash-resistance

## TECHNICAL BSLBATT LITHIUM CURVE

ENVIRONMENT TEMPERATURE: 25°C

DISCHARGE CURRENT: 0.5C/1C/3C/5C

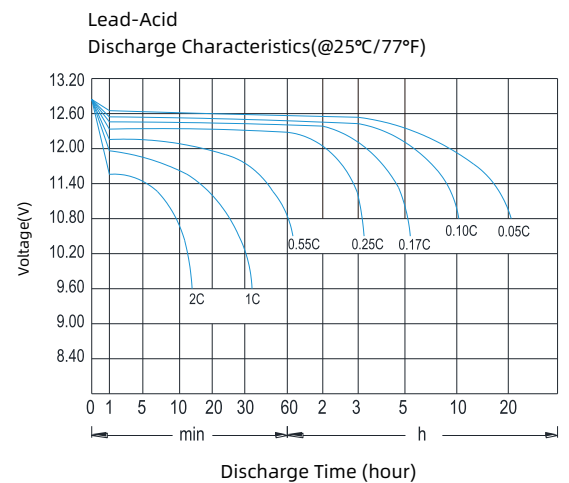
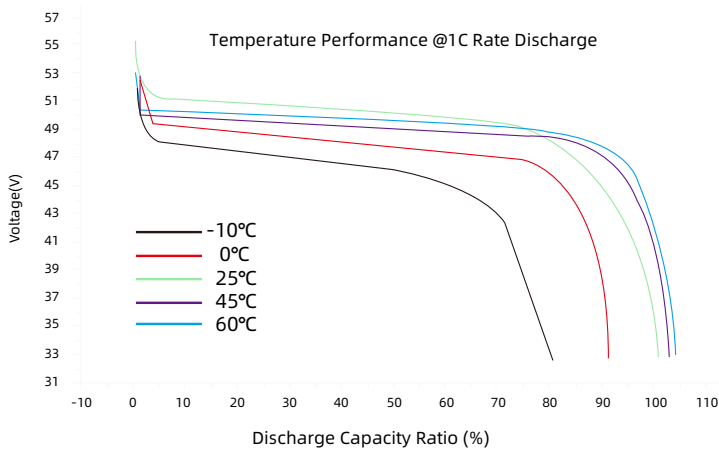

BSLBATT lithium battery has a longer constant stable curve during discharge.