

They are designed to replace the lead-acid battery, which are available for drop-in replacement in the Club Car and EZ-GO etc. vehicles nicely.

- MODEL** B-LFP72-160GC
- VOLTAGE** 76.8V (Display voltage: 79.2V)
- NOMINAL CAPACITY** 160Ah
- CASE** METAL/FR
- BATTERY** Lithium-iron (LFP)
- COLOR** BLUE
- CYCLE LIFE** 3500 @80%DOD
- INTELLIGENCE** Multiple Microprocessors, State of Charge Gauge with Aging Compensation, Current Sensor, Fuse, CAN Bus



ELECTRICAL SPECIFICATIONS

Battery Types	Lithium-iron (LFP)
Rated Capacity	160Ah
Nominal Voltage	76.8V Display voltage: 79.2V
Operating Voltage Range	60V-86.4V Battery cell: 2.5V-3.65V
System Capacity	11.981 kWh
Battery Group Solution	3P24S A boxful
IP Protection Level	Battery system IP54
Cycle Life	> 3500 times 25°C, 05C charge, 1C discharge, DOD 70% (soc 0-100%)
Battery System Weight	112KG
Calendar Life	12 years 25°C, SOC 100%, EOL 80%

TEMPERATURE SPECIFICATIONS

Operating Temperature Range A Column Temperature	Charge	0°C-55°C
	Discharge	-20°C +55°C

PHYSICAL SPECIFICATIONS

Battery Pack Factory SOC	50%
Battery SOC Operating Range	0-100%
Insulation Requirements	≥20MΩ/1000VDC 25°C ± 5°C, RH50%
The Power Consumption Of The BMS	≤3W
SOC Theory Estimation Accuracy	±5%
Unit Voltage Acquisition Accuracy	±5mV Capture every single monomer
Temperature Acquisition Accuracy	±2°C 4 road
Current Acquisition Accuracy	≤ ± 0.5% FSR
Equalizing Current	≤ 100mA Passive equalization
Protect Function	Over-current protection, over-discharge protection, high and low temperature protection, abnormal alarm function.



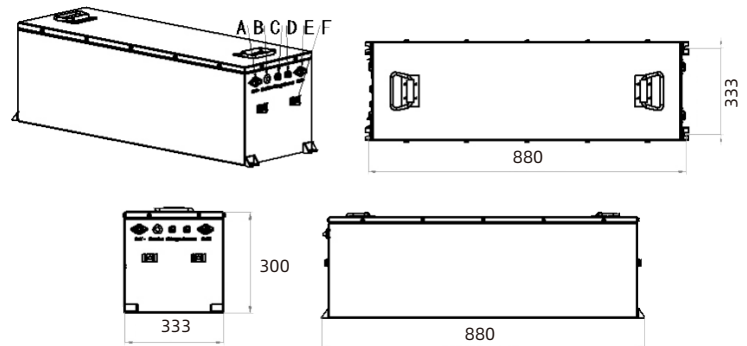



DIMENSIONAL SPECIFICATIONS



DISCHARGE SPECIFICATIONS

Maximum Continuous Charging Current	80A	10°C-45°C, 5% < SOC < 80%
Maximum Continuous Discharging Current	200A	5°C-50°C, SOC > 20%
Maximum Instantaneous Charging Current (10S)	150A	10°C-45°C, 5% < SOC < 80%
Maximum Instantaneous Discharging Current (10S)	400A	5°C-50°C, SOC > 20%
Standard Charging Current Is Recommended	< 40A	
Self-discharge Rate/Month (25°C, SOC100%)	< 3%	

FIVE YEAR COST COMPARISON BETWEEN BSLBATT & LEAD ACID BATTERIES

	YEAR 1	YEAR 2	YEAR 3	YEAR 4	YEAR 5
 \$ Cost Of Battery	\$\$\$\$	\$			
 Installation	\$				
 Maintenance					
 Maintenance					
 Maintenance					
 Battery Change					
Total					\$\$\$\$\$\$
 \$ Cost Of Battery	\$	\$	\$	\$	\$
Total					\$\$\$\$\$\$\$\$



Do not mix with lead-acid batteries when recycling to 70% initial capacity

B-LFP72-160 LITHIUM-ION BATTERY

GOLF



STRUCTURAL DIFFERENCES IN THE BSLBATT GOLF CART SERIES

Each Cell Is Encased In Aluminum

- ✔ Provides dimensional stability

Steel Battery Bracket

- ✔ Provides vibration and shock resistance

External Heat Sink Keeps

- ✔ BMS cool by providing heat dissipation to outside

BMS Bolted To Heat Sink

- ✔ Reduces vibration and prevents accidental faults due to vibration and it extends battery life

Bolted Connections To BMS

- ✔ Provides stable mechanical and electrical connections

Positive And Negative BusBar

- ✔ Creates an exceptional current collector

IP54 Rated Casing

- ✔ Ensures water, dust and splash-resistance

TECHNICAL BSLBATT LITHIUM CURVE

ENVIRONMENT TEMPERATURE: 25°C

DISCHARGE CURRENT: 0.5C/1C/3C/5C

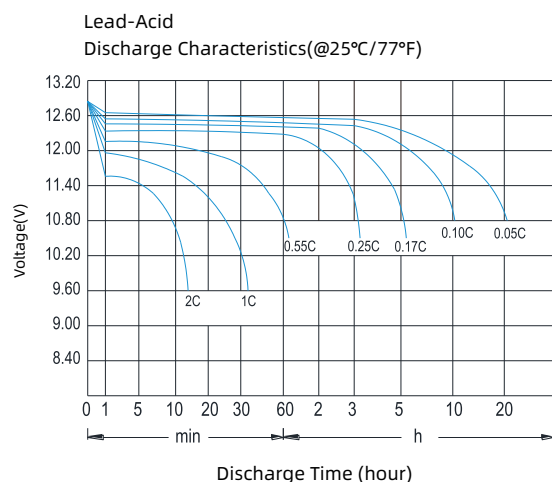
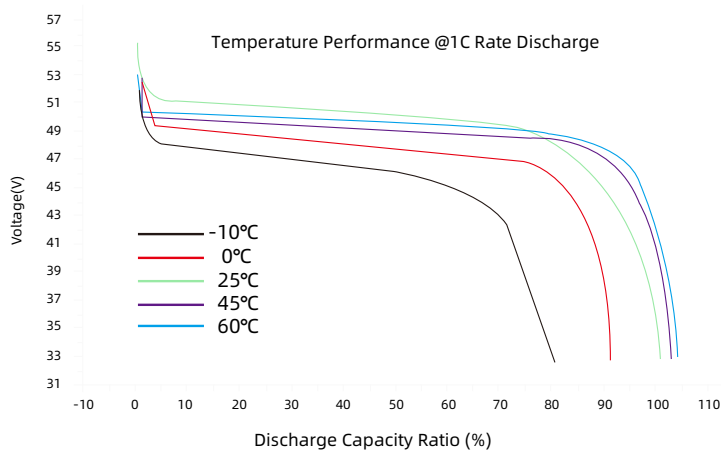

BSLBATT lithium battery has a longer constant stable curve during discharge.